

Artikuls	Specifikācija	Skaits lepak
W805 Ant.	Konsole "Antikā"	2 gb.
W1007 Ant	Konsole "Antikā"	2 gb.
W503 Ant.	Konsole "Antikā"	2 gb.



Artikuls	Specifikācija	Skaits lepak
W2023/1	Konsole "Antikā"	2 gb.
W2023/2	Konsole "Antikā"	2 gb.
W2023/3	Konsole "Antikā"	2 gb.



Artikuls	Specifikācija	Skaits lepak
W2024/1CH	Konsole Elegance, kompl.	
W2024/1MP	Elegance, komplekts, misiņots	
W2024/1zila	Konsole Elegance, kompl.	
W2024/2 zila	Konsole Elegance, kompl.	
W2024/2CH	Konsole Elegance, kompl.	



Artikuls	Specifikācija	Skaits lepak
W2028 akvamarīna	Konsole "Milāna" 16x9cm	2 gb.
W2028 balta	Konsole "Milāna" 16x9cm	2 gb.
W2028 bēša	Konsole "Milāna" 16x9cm	2 gb.
W2028 vaniļas	Konsole "Milāna" 16x9cm	2 gb.



Artikuls	Specifikācija	Skaits lepak
W1995/1 zils	Konsoļu komplekts	2 gb.
W1995/1 sudr.	Konsoļu komplekts	2 gb.



Konsoles un Stiprinājumi

SIA ITF "FERMERIS" TĀLR. +37167547382

FAKSS +37167840386

GSM +37129224977; +37129102661

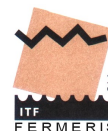

Artikuls	Specifikācija	Skaits lepak.
WA100X75	Balta, brūna, pelēka 100X75 mm	24 gb.
WA125x100	Balta, brūna, pelēka 125x100 mm	24 gb.
WA150x125	Balta, brūna, pelēka 150x125 mm	24 gb.
WA175x150	Balta, brūna, pelēka 175x150 mm	24 gb.
WA200x150	Balta, brūna, pelēka 200x150 mm	24 gb.
WA250x200	Balta, brūna, pelēka 250x200 mm	24 gb.
WA300x250	Balta, brūna, pelēka 300x250 mm	24 gb.
WA350x300	Balta, brūna, pelēka 350x300 mm	24 gb.
WM400x350	Balta, brūna, pelēka 400x350 mm	10 gb.
WM450x400	Balta, brūna, pelēka 450x400 mm	10 gb.



Artikuls	Specifikācija	Skaits lepak.
W2026/1 balta	12cm, balta	10 gb.
W2026/1 brūna	12cm, brūna	10 gb.
W2026/1 dzeltena	12cm, dzeltena	10 gb.
W2026/1 melna	12cm, melna	10 gb.
W2026/2 balta	15x11cm, balta	10 gb.
W2026/2 brūna	15x11cm, brūna	10 gb.
W2026/2 dzeltena	15x11cm, dzeltena	10 gb.
W2026/2 melna	15x11cm, melna	10 gb.
W2026/2 sarkana	15x11cm, sarkana	10 gb.
W2026/3 brūna	W20x14cm, brūna	10 gb.
W2026/3 dzeltena	W20x14cm, dzeltena	10 gb.
W2026/3 melna	W20x14cm, melna	10 gb.
W2026/3 sarkana	W20x14cm, sarkana	10 gb.
W2026/4 balta	24x15cm, balta	10 gb.
W2026/4 brūna	24x15cm, brūna	10 gb.
W2026/4 dzeltena	24x15cm, dzeltena	10 gb.
W2026/4 melna	24x15cm, melna	10 gb.
W2026/5 balta	28x17cm, balta	10 gb.
W2026/5 brūna	28x17cm, brūna	10 gb.
W2026/5 dzeltena	28x17cm, dzeltena	10 gb.
W2026/5 melna	28x17cm, melna	10 gb.
W2026/5 sarkana	28x17cm, sarkana	10 gb.
W2026/6 balta	34x18cm, balta	10 gb.
W2026/6 brūna	34x18cm, brūna	10 gb.
W2026/6 dzeltena	34x18cm, dzeltena	10 gb.
W2026/6 melna	34x18cm, melna	10 gb.
W2026/6 sarkana	34x18cm, sarkana	10 gb.
W2026/7 balta	38x22cm, balta	10 gb.
W2026/7 brūna	38x22cm, brūna	10 gb.
W2026/7 dzeltena	38x22cm, dzeltena	10 gb.
W2026/7 melna	38x22cm, melna	10 gb.



Artikuls	Specifikācija	Skaits lepak
WW2022/1	30x16 cm, anodēta ,nesalikta	20gb.
W2022/2	40x21cm, anodēta ,nesalikta	20gb.
W2022/7	50x23, anodēta ,nesalikta	20gb
W2022/3	30x16cm, anodēta	6gb.
W2022/5 sarkana	30x16cm, sarkana	6gb
W2022/5 SV	30x16 /melna/	6gb
W2022/5 VL	30x16 /balta/	6gb
W2022/6 sarkana	40x21cm, sarkana	6gb
W2022/6 SV	40x21cm, melna	6gb
W2022/6 VL	40x21 /balta/	6gb
W2022/9 sarkana	50x23cm, sarkana	6gb
W2022/9 SV	50x23 /melna/	6gb
W2022/9 VL	50x23, /balta	6gb



Stiprinājumi

SIA ITF "FERMERIS" TĀLR. +37167547382
 FAKSS +37167840386
 GSM +37129224977; +37129102661



Konsole „Obelix”



ARTIKULS	Specifikācija
w2043/1	300x190 mm , Svarizturība - 100 Kg
w2043/2	400x250 mm , Svarizturība - 100 Kg
w2043/3	500x310 mm , Svarizturība - 100 Kg

Konsole „DEA”



ARTIKULS	Svarizturība	Iepakots
W2041/1 balta	120x80mm, 20 Kg	κ pa 2 gb
W2041/1 krēmkrāsa	120x80mm, 20 Kg	κ pa 2 gb
W2041/2 balta	180x120mm, 25 Kg	κ pa 2 gb
W2041/2 krēmkrāsa	180x120mm, 25 Kg	κ pa 2 gb
W2041/3 balta	240x140mm, 25 Kg	κ pa 2 gb
W2041/3 krēmkrāsa	240x140mm, 25 Kg	κ pa 2 gb
W2041/1 Smilšukrāsa	120x80mm, 20 Kg	В pa 2 gb
W2041/1 Koka Kr.	120x80mm, 20 Kg	В pa 2 gb
W2041/2 Smilšukrāsa	180x120mm, 25 Kg	В pa 2 gb
W2041/2 Koka Kr.	180x120mm, 25 Kg	В pa 2 gb
W2041/3 Smilšukrāsa	240x140mm, 25 Kg	В pa 2 gb
W2041/3 Koka Kr.	240x140mm, 25 Kg	В pa 2 gb

Kronšteins kondicionētājiem un citām iekārtām

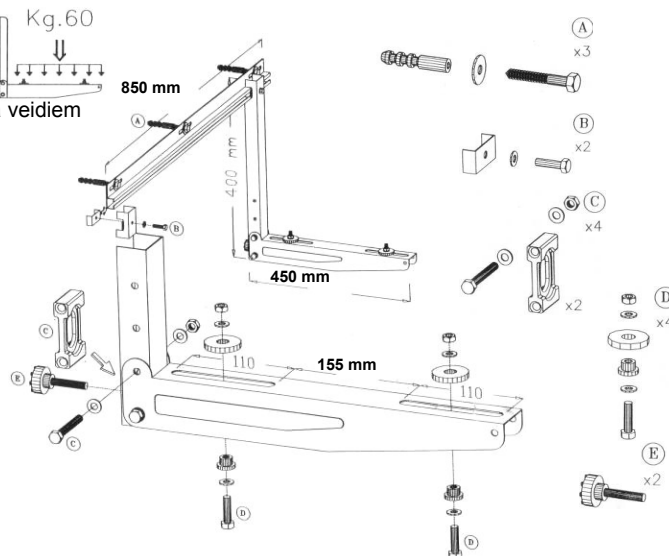
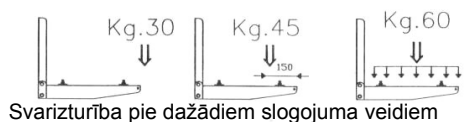

ARTIKULS	Specifikācija
w2044/4 VL	Balti krāsots
w2044/2 VL	

Cenas norādītas ar PVN 18%

K?K

B



Kaste (iekarama standā) Blisters

Stiprinājumi

SIA ITF "FERMERIS" TĀLR. +37167547382
 FAKSS +37167840386
 GSM +37129224977; +37129102661

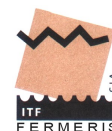

tapveida konsole ar melnu plastikas pārklājumu



ARTIKULS	Specifikācija	Iepakojums
	Ø 12x120 mm , svarizturība 50 kg	30gb
W2021/3	Ø 12x170 mm , svarizturība 50 kg	30gb
W2021/4	Ø 10x100 mm , svarizturība 35 kg	40gb
W2021/5	Ø 10x150 mm , svarizturība 35 kg	40gb
W2021/6	Ø 8x100 mm , svarizturība 30 kg	50gb
W2021/7	Ø 8x150 mm , svarizturība 30 kg	50gb

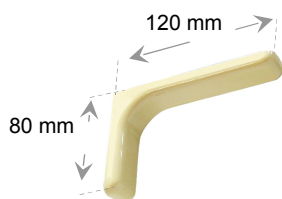

ARTIKULS	Specifikācija	Iepakojums
w2005 Balta	Svarizturība 20 Kg	κ* 2 gb
w2005 Rozā	Svarizturība 20 Kg	κ 2 gb
w2005 Krēmkrāsa	Svarizturība 20 Kg	κ 2 gb
w2000/ST	20 Kg,(bez stiprinājumiem)	κ 2 gb

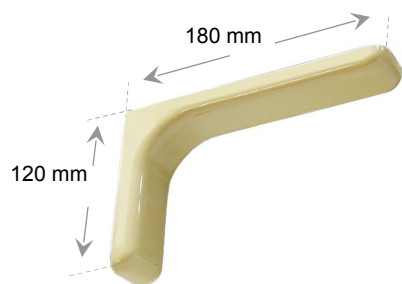

ARTIKULS	Svarizturība	Iepakots
2006 Balta	25 Kg	κ pa 2 gb
2006 Bēša	25 Kg	κ pa 2 gb
2006 Krēmkrāsa	25 Kg	κ pa 2 gb
W2008/1 Balta	25 Kg	В pa 2 gb
W2008/1 krēma	25 Kg	В pa 2 gb
W2008/1 rozā	25 Kg	В pa 2 gb
W2008/1 dzeltena	25 Kg	В pa 2 gb
W2008/1 bēša	25 Kg	В pa 2 gb
W2008/1 smilšu	25 Kg	В pa 2 gb
W2008/1 melna	25 Kg	В pa 2 gb
W2008/1 brūna	25 Kg	В pa 2 gb
W2008/1 g-brūna	25 Kg	В pa 2 gb
W2008/1 g-zila	25 Kg	В pa 2 gb
W2008/1 zaļa	25 Kg	В pa 2 gb
W2008/1 sarkana	25 Kg	В pa 2 gb
W2008/1 zelta kr	25 Kg	В pa 2 gb
W2008/1 hromēta	25 Kg	В pa 2 gb
w2000/1	25 Kg,(bez stiprinājumiem)	κ pa 2 gb

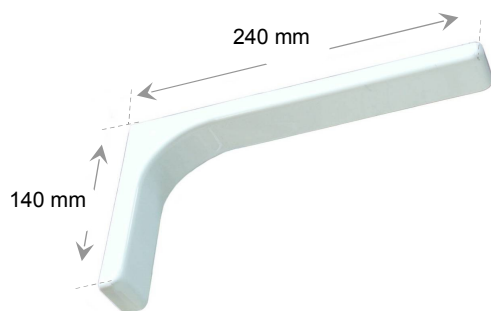

ARTIKULS	Specifikācija	Iepakots
W2007 Balta	25 Kg	κ pa 2 gb
W2007 Rozā	25 Kg	κ pa 2 gb
W2007 Krēmkrāsa	25 Kg	κ pa 2 gb
w2000/2	25 Kg,(bez stiprinājumiem)	κ pa 2 gb

*Iepakojums

κ?K B



Kaste

(iekarama standā) Blisters

Cenas norādītas ar PVN 18%